

TDD40 SERIES

DC - DC CONVERTER
33 ~ 42W SINGLE & DUAL OUTPUT



FEATURES

- EFFICIENCY UP TO 87%
- 2:1 & 3:1 WIDE INPUT RANGE
- I/O ISOLATION
- INPUT Pi FILTER
- SHORT CIRCUIT PROTECTION
- HIGH PERFORMANCE
- 3 YEARS WARRANTY

MODEL LIST

MODEL NO.	INPUT VOLTAGE	INPUT CURRENT (typ.)	OUTPUT WATTAGE	OUTPUT VOLTAGE	OUTPUT CURRENT	EFF. (min.)	EFF. (typ.)	CAPACITOR LOAD (max.)
Single Output Models								
TDD40 - 03S2	18~60 VDC	1.79 A	33 WATTS	+3.3 VDC	10000 mA	76%	78%	3500 μ F
TDD40 - 05S2	18~60 VDC	2.01 A	40 WATTS	+ 5 VDC	8000 mA	82%	84%	3500 μ F
TDD40 - 12S2	18~60 VDC	2.04 A	42 WATTS	+ 12 VDC	3500 mA	85%	87%	330 μ F
TDD40 - 15S2	18~60 VDC	2.01 A	42 WATTS	+ 15 VDC	2800 mA	85%	87%	220 μ F
TDD40 - 03S3	35~75 VDC	0.89 A	33 WATTS	+3.3 VDC	10000 mA	76%	78%	3500 μ F
TDD40 - 05S3	35~75 VDC	0.96 A	40 WATTS	+ 5 VDC	8000 mA	82%	84%	3500 μ F
TDD40 - 12S3	35~75 VDC	1.00 A	42 WATTS	+ 12 VDC	3500 mA	85%	87%	330 μ F
TDD40 - 15S3	35~75 VDC	1.00 A	42 WATTS	+ 15 VDC	2800 mA	85%	87%	220 μ F
Dual Output Models								
TDD40 - 12D2	18~60 VDC	1.97 A	40 WATTS	\pm 12 VDC	\pm 1700 mA	84%	86%	\pm 470 μ F
TDD40 - 15D2	18~60 VDC	2.05 A	42 WATTS	\pm 15 VDC	\pm 1400 mA	84%	86%	\pm 100 μ F
TDD40 - 12D3	35~75 VDC	0.98 A	40 WATTS	\pm 12 VDC	\pm 1700 mA	84%	86%	\pm 470 μ F
TDD40 - 15D3	35~75 VDC	0.99 A	42 WATTS	\pm 15 VDC	\pm 1400 mA	84%	86%	\pm 100 μ F

SPECIFICATION

All Specifications Typical At Nominal Line, Full Load, 25°C Unless Otherwise Noticed

GENERAL					
Characteristics	Conditions	min.	typ.	max.	unit
Switching frequency	Vi nom, Io nom		300		KHz
Isolation voltage	Input - Output	1,500			VDC
Isolation resistance	Input - Output, @ 500VDC	100			MΩ
Isolation capacitance	100KHz / 1V			1,000	PF
Ambient temperature	Vi nom, 3.3V & 5V output models	-25		+ 61	°C
	Io nom 12V, 15V & dual output models	-25		+ 71	°C
Case temperature	Operating at Vi nom, Io nom			+ 100	°C
Derating	Vi nom	See derating curve			
Storage temperature	Non operational	-40		+ 100	°C
Relative humidity	Vi nom, Io nom	20		95	% RH
Temperature coefficient	Vi nom, Io min			± 0.02	% / °C
Dimension		L76.2 x W50.8 x H24.4			mm
MTBF	Belcore issue 6@40°C, GB		681,000		Hours
Cooling	Free air convection				

INPUT SPECIFICATIONS					
Characteristics	Conditions	min.	typ.	max.	unit
Input voltage range	Ta min ... Ta max, Io nom	18	24	60	VDC
		35	48	75	VDC
No load input current	Vi nom, Io=0	24V		20	mA
		48V		15	mA
Input voltage w/o damage	Io nom	24V		65	VDC
		48V		80	VDC
Startup voltage	Io nom	24V	16		VDC
		48V	30		VDC
Input filter	Pi type				

OUTPUT SPECIFICATIONS					
Characteristics	Conditions	min.	typ.	max.	unit
Output voltage accuracy	Vi nom, Io nom			± 2	%
Minimum load	Vi nom single output models	0			%
	dual output models (each output)	6			%
Line regulation	Io nom, Vi min ... Vi max			± 1	%
Load regulation	Vi nom, Io 0 ... Io nom, single output models			± 2	%
	Vi nom, Io min ... Io nom, dual output models			± 5	%
Cross regulation (Dual model)	Aymmetrical load 6% - 100% FL			± 5	%
Startup time	Vi nom, Io nom			30	ms
Transient recovery time	Vi nom, 1~0.5 Io nom			500	μs
Ripple & noise	Vi nom, Io nom, 3.3V & 5V			150	mV
	BW = 20MHz 12V, 15V & dual			Vout x±1%	mV
Voltage trim range *	Vi nom 3.3V		± 5		%
	5V, 12V, 15V & dual		±10		%
Efficiency	Vi nom, Io nom, Po / Pi	Up to 87%, See model list and efficiency curve			

* NOTE : Pls refer to Fig 1 & Table 1 for connection resistance recommended.

CONTROL AND PROTECTION	
Remote ON / OFF	ON: opened or 8 ~ 10VDC applied, reference to input GND OFF: -0.3 ~ 2VDC applied, reference to input GND
Input reversed	Shunt diode built in, external fuse recommended 3A
Output short circuit	Current limited (Auto-recovery)
Rated over load protection	110%min....140%max

PHYSICAL CHARACTERISTICS

Case size	76.2 x 50.8 x 24.4 mm (3 x 2 x 0.96 inches)
Case material	Plastic base / Metal case
Weight	175 g
Potting material	Epoxy

MECHANISM & PIN CONFIGURATION

mm [inch]

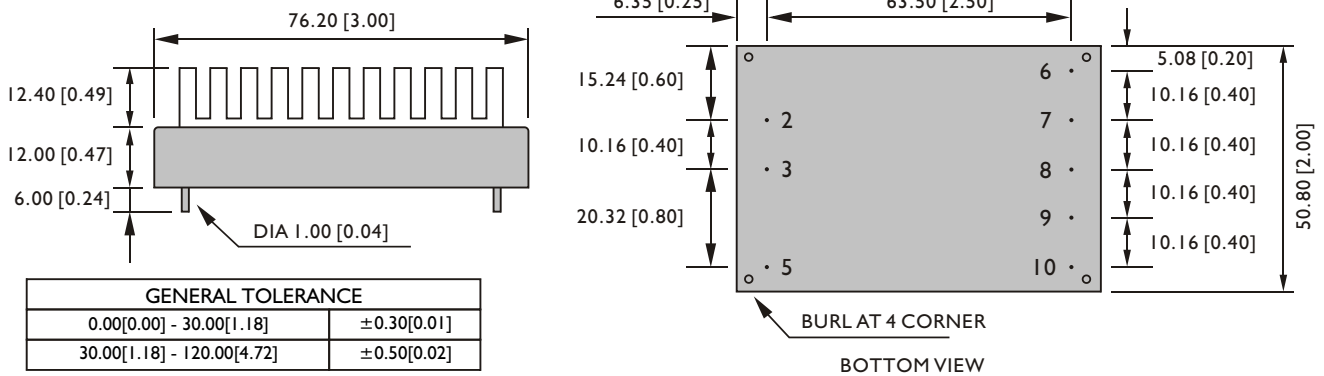

GENERAL TOLERANCE	
0.00[0.00] - 30.00[1.18]	±0.30[0.01]
30.00[1.18] - 120.00[4.72]	±0.50[0.02]

PIN ASSIGNMENT

GENERAL

PIN NO.	2	3	5	6	7	8	9	10
SINGLE	Vi -	Vi +	ON / OFF	N. C.	N. C.	Vo -	Vo +	Trim
DUAL	Vi -	Vi +	ON / OFF	Vo -	N. C.	com	Vo +	Trim

CIRCUIT SCHEMATIC

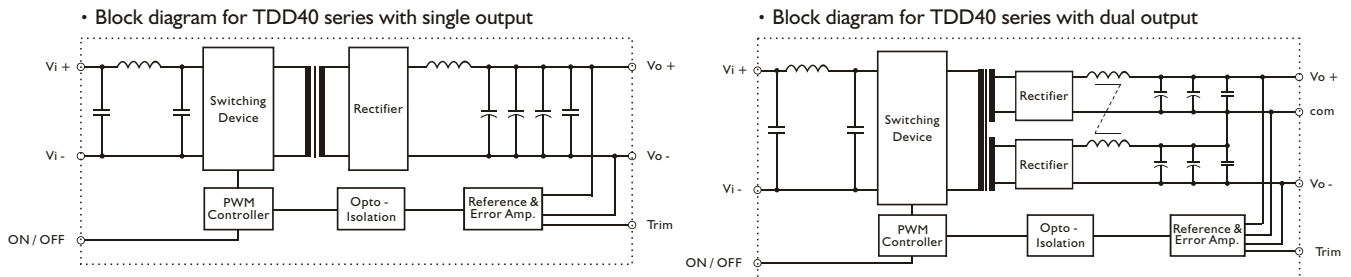

RECOMMENDED CIRCUIT

- Recommended filter for EN55022 Class B compliance.

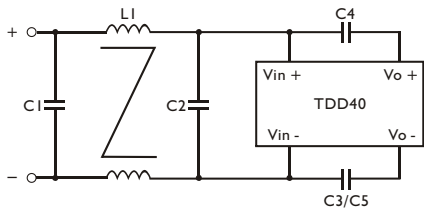

- The components used in the above figure, together with the manufacturer part numbers for these components, are as follows.

	C1	C2	C3/C4/C5	L1
TDD40-XXSX	3.3 μF / 100V MLCC	3.3 μF / 100V MLCC	InF / 2KV MLCC	1.5mH Command Chock
TDD40-XXD2	6.8 μF / 100V MLCC	6.8 μF / 100V MLCC	InF / 2KV MLCC	500 μH Command Chock
TDD40-XXD3	6.8 μF / 100V MLCC	6.8 μF / 100V MLCC	2.2nF / 2KV MLCC	500 μH Command Chock

- Recommended EN 55022 Class B filter circuit layout.

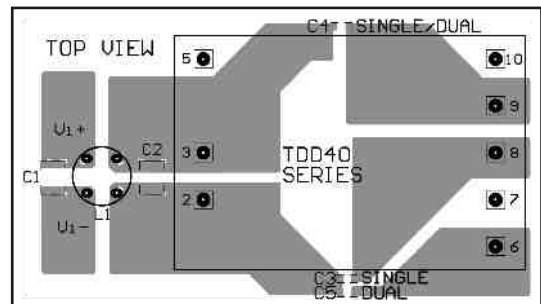

DERATING AND EFFICIENCY CURVE

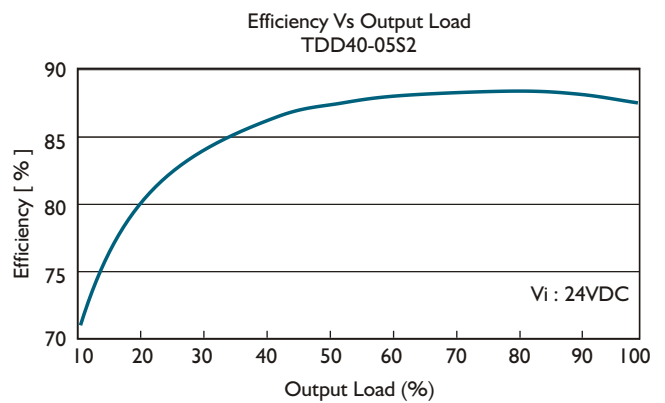
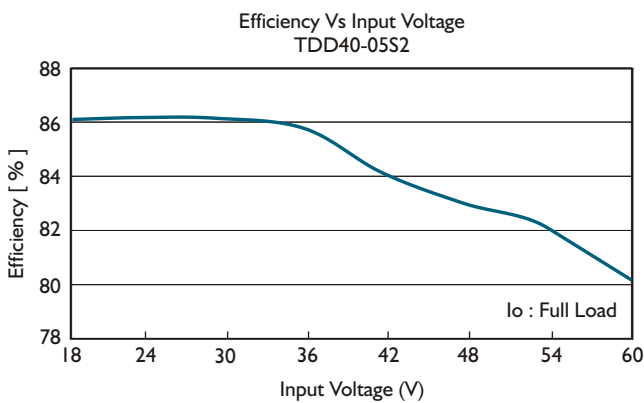
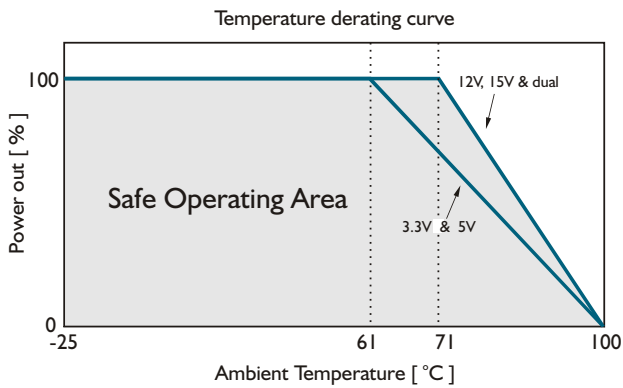
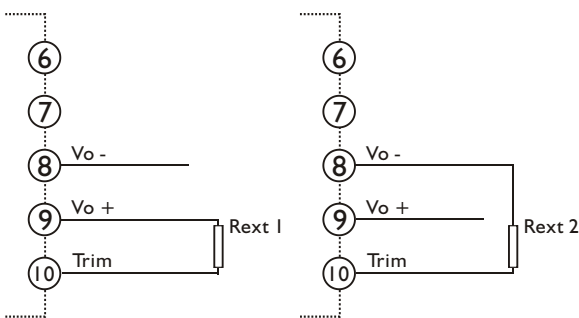

Fig. 1 Trim connection

(For Single output)



(For Dual output)

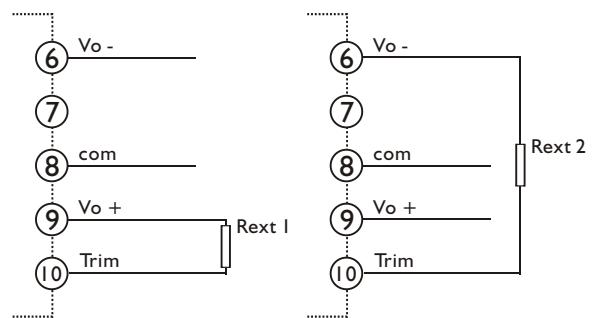

Table I Typical resistor values for various output voltage adjustment settings

Type	Rext 1		Rext 2	
	Vo nom -2.5%	Vo nom -5%	Vo nom +2.5%	Vo nom +5%
TDD40-03SX	1KΩ	0Ω	10KΩ	3.9KΩ
Type	Vo nom -5%	Vo nom -10%	Vo nom +5%	Vo nom +10%
TDD40-05SX	1KΩ	0Ω	1KΩ	0Ω
TDD40-12SX	62KΩ	20KΩ	8.2KΩ	1KΩ
TDD40-15SX	180KΩ	62KΩ	20KΩ	0Ω
TDD40-12DX	100KΩ	51KΩ	10KΩ	1KΩ
TDD40-15DX	180KΩ	68KΩ	10KΩ	0Ω